

Characterization of signal propagation in neuronal systems for nanomachine-to-neurons communications

Laura Galluccio, Sergio Palazzo, Giuseppe E. Santagati
 Dipartimento di Ingegneria Elettrica, Elettronica e Informatica (DIEEI)
 University of Catania (Italy)
 Email: {name.surname}@diit.unict.it

Abstract—In the next decade nanocommunications will have great impact on biomedical engineering applications, for example in the view of allowing rehabilitation of patients which suffer for irreversible damage to the vertebral column. In such a case, the impossibility to move caused by an interruption in the propagation of nervous impulses, could be solved by exploiting nanomachines that employ the same communication paradigm of neurons to interact with them, thus allowing signal propagation across the body critical area. Accordingly, in this paper we perform a characterization and provide a model of the signal propagation between two entities which use a neuronal paradigm of communication, e.g. two neurons or a neuron and a nanomachine, so as to derive expressions of the transfer function, gain and delay incurred during the transmission. This could allow to design nanomachines compatible with the biological structures and able to integrate and substitute them when needed.

I. INTRODUCTION

Nanocommunications have been envisaged as a very pioneering communication paradigm which is deemed to provide significant advances to health care, biomedical as well as environmental and military applications [1]. However, whatever will be the system where nanomachines will be integrated, signal propagation should be characterized with high detail. In nanonetworks this task is difficult to be achieved since various communication paradigms have been discussed in the last years. Essentially, two classes of paradigms have been introduced: purely molecular and electromagnetic. *Molecular communications* [6] exploit chemical diffusion of particles and molecules as in living organisms while also performing coding and information transmission through chemical features. Different molecular communication ranges can be considered, as proposed in [1], [5]: short range communications (few nm to μm), where calcium signaling [12] or molecular motors [11] can be used to propagate information; medium range communications (μm to mm), where flagellated bacteria and catalytic nanomotors have been proposed as carriers [5]; long range communications (few mm) where pheromones, pollens and spores, as well as neurons, have been considered but no specific physical models have been proposed yet [13]. *Electromagnetic communications*, on the other hand, rely on use of appropriate transmitters and receivers [7], [16] as well as exploitation of carbon nanotube antennas [8], [10], [2] which are currently at an initial design stage. Also in this

case much attention has been devoted to design RF circuitry to support such kind of communications and explore channel capacity [9]. In this paper we investigate a hybrid (molecular and electromagnetic) communication paradigm to characterize signal propagation in neuronal systems. To this purpose, molecular emissions, transduction and diffusion in a neuron-to-neuron scenario are modeled. The system is decomposed into blocks, and delay and gains for each block are given as a function of the operating frequency. Moreover, frequencies at which the signal propagation could be effective are identified in the perspective of supporting the communication between nanomachines and neurons. The potentialities of this study are numerous especially in biomedical applications since in the next future nanomachines could allow the propagation of nervous impulses across body regions irreversibly damaged as a consequence of an accident or a disease (for example, an interruption along the vertebral column, Alzheimer, etc.).

The rest of this paper is organized as follows. In Section II we describe the neuron structure. In Section III we provide a mathematical characterization of signal propagation in neuronal systems which is then used in Section IV to investigate on the neuronal system frequency behavior. Finally, in Section V, concluding remarks are drawn.

II. NEURON STRUCTURE FOR EC ENGINEERS

Target of this section is to describe how signals are transmitted in a biological nervous communication system with a language which can be easily understood by electrical and computer engineers.

The nervous system is organized as a network of neurons. Each neuron receives inputs by a certain number N of other neurons and provides output to other M neurons¹. To this purpose, it is composed of *dendrites* which can be identified with the input interface, an *axon* used as the output interface, and a cell body, called *soma*, which implements the system logic².

¹Observe that, in general, neurons can receive input from and provide output to other cells besides neurons. We here do not consider this to keep our discussion easier.

²There are different specialized types of neurons which can have slightly different structures but, in the rest of this paper, we will refer to the generic structure mentioned above.

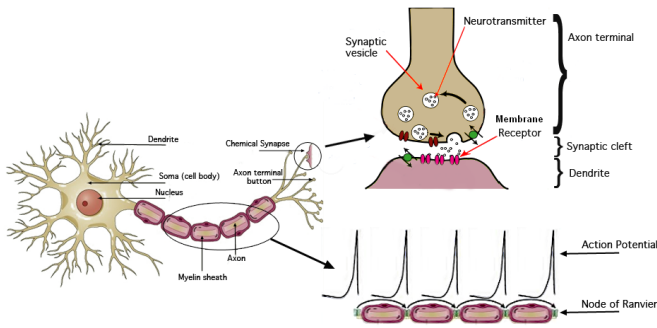

Fig. 1. Neuron model.

The axon arises from the cell soma at the *axon hillock* characterized by a high concentration of ions channels. External signals reach the dendrites, propagate through the soma, and, once in the axon hillock, depending on the strength, can generate an *Action Potential* propagated throughout the axon till the *axon terminal button*, where the *synapse*, i.e. a junction, allows signal propagation to other cells.³ The axon can be up to one meter long (e.g. in the ischiatic nerve of human beings) and can be wrapped up by a *myelin sheath* used to shield the signal and allow propagation on a longer range; alternatively, the axon could be also unshielded and not wrapped by the myelin sheath. In case of nerve fibers, axon is always myelinated to guarantee higher propagation speed and lower energy consumption. Observe that, due to the possible significant axon length, a high attenuation of the action potential while traveling along it could be met. To decrease the impact of channel attenuation in the axon, the myelin sheath is interrupted at some gap locations along the axon called *Ranvier nodes*. The typical size of these interruptions is around $1\mu m$. Ranvier nodes are locations where electrical signals can be regenerated due to the high concentration of voltage-gated ion channels. Action potential is regenerated at these sites so that it finally comes at the axon terminal button. The result of the regeneration of the action potential at the Ranvier nodes is the, so called, *saltatory conduction*. Once the action potential reaches the axon button terminal it leads to neurotransmitters' emission across the *synapse* that is the junction between a pair of neurons. At the postsynaptic element, binding between neurotransmitters and receptors implies generation of a synaptic current and, again, propagation of the action potential through a different neuron. The scheme of a generic neuron is shown in Fig. 1.

In this paper we characterize how signals propagate from dendrites (i.e. input interface of the neuron) to the axon terminal button (output interface of the neuron); however, before describing such a system, we need to introduce some basics on general cellular structure.

³Observe that two types of synapses exist: electrical (rarely) and chemical (more commonly). In the rest of this paper we will focus only on chemical synapses since they are the most widespread in biological creatures.

A. Cellular membrane

The cellular membrane is a fundamental element of all cells, including neurons. The membrane separates the internal cytoplasm from the extracellular medium.

Distribution of ions⁴ in a cell is not at an equilibrium; in fact, there always exists a ion gradient which causes a diffusion process across the cellular membrane; this is fundamental for cells' activity. As an example consider that typically there is an excess of sodium and chlorine ions Na^+ and Cl^- outside, and potassium ions K^+ inside. This difference in ions' concentration induces a voltage difference also when the cell is not hit by any stimula. This voltage difference is called *resting potential*. The ion gradient is maintained through an active transport system which continuously contrasts passive diffusion due to chemical equilibrium. Existence of stable ion gradient between the internal and external parts of a cell leads to a variation in membrane electrical potential. Membrane potential is the triggering element during nervous excitement since it allows the generation of electrical signals needed by neuronal communication. It is possible to efficiently modulate the membrane potential amplitude simply varying the membrane permeability to specific ions.

Cell membrane consists of a phospholipid bilayer with embedded proteins able to perform basic functionalities for cell activity. The main membrane proteins can be classified as *Membrane receptors*, *Ion channels* and *Ion pumps*. *Membrane receptors* can bind only to certain molecules (called *ligands*), thus causing the activation of a specific biological or chemical effect. The membrane receptors involved in neuronal communications are placed in the dendrites and bind to certain proteins called neurotransmitters which are released in the synapse by the axon terminal button of a previous neuron.

Ion channels form aqueous pores in the phospholipid bilayer that allow ions' exchange through membrane. Obviously the voltage difference at the cellular membrane can be modulated by varying the number of open ion channels on the following of the binding between the receptors and the neurotransmitters due to the propagation of an action potential.

Ion pumps carry ions against their concentration gradient using energy from ATP (Adenosine Triphosphate) hydrolysis and allow *membrane active transport* to maintain voltage difference at the cellular membrane.

B. Action Potential

When neurons are stimulated by external sources (e.g. during neuronal excitation), basically two types of responses take place: passive and active. Experimental tests show that, if electrical current flows through cell membrane, this reacts passively like a RC parallel circuit where R is the resistive component of ions' transportation through ion channels at the membrane, and C represents the membrane capacitive component associated to the dielectric properties of the phospholipid bilayer.

⁴Ions are electrically charged particles.

In addition to a passive response, an excitable cell also exhibits an active response, called *Action Potential* or *spike*. If external stimulus is strong enough to make the membrane potential rise up to a threshold value, a depolarization occurs, and the response activates an *all-or-none* event in which the electrical membrane potential of a cell rapidly rises and then falls. The reason for this behavior is that when the sodium channels are open, they allow an incoming flow of sodium ions, which changes the electrochemical gradient; this in turn leads to a depolarization in the membrane potential which causes more sodium channels to open, producing a greater electric current. The process goes on until all the available sodium channels are open, causing a rise in the membrane potential. Due to the incoming flux of sodium ions, the membrane reverses its polarity and the ion channels then rapidly inactivate. When the sodium channels close, ions can no longer enter the neuron and are transported out the plasma membrane. Potassium channels are then activated so reporting the electrochemical gradient to the initial resting state.

The Action Potential cannot be reinvoked immediately but there is an Absolute Refractory Period (ARP) that must elapse before a new Action Potential can be invoked due to the reactivation time in the ion channels.

C. Synaptic transmission

Transmission of electrical signals between excitable cells (e.g. neurons) takes place in specialized sites called *synapses*. Transmitter and receiver cells are defined as *presynaptic* and *postsynaptic* cells. Space between the two parts is called *synaptic cleft*. According to the communication strategy being used, we can classify synapse into electrical and chemical. The former allows direct communication between presynaptic and postsynaptic cells using electrical signals. The latter leads to a double signal transduction during transmission. Action potential generated by a presynaptic cell is transduced into a chemical signal, i.e. neurotransmitter concentration, which once reaches the postsynaptic cell, is re-transduced into a membrane potential.

Neurotransmitters' release in the synaptic cleft is caused by the Action Potential generated at the presynaptic cell, which forces neurotransmitter exocytosis from special containers called *synaptic vesicles* (see Fig. 1).

III. MODEL

Our objective is to model signal propagation between two neurons. This communication system can be represented as shown in Fig. 2. In this figure two entities are depicted, TX and RX. In the rest of this paper we will model the blocks inside the dotted line which correspond to the condition when the signal enters the presynaptic element of the TX and then leaves the axon of the RX.

As depicted in the scheme, this communication system can be considered as composed of different blocks; each of them properly models a phase in neuronal communication. In the following we will analyze in detail each block, describing how

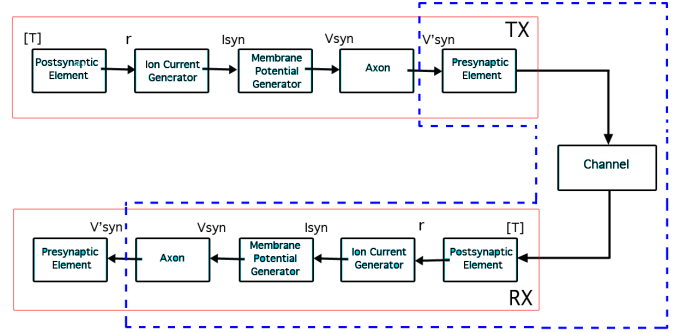

Fig. 2. System building blocks.

it works and how it is characterized in term of input/output relationship, gain and delay.

A. Presynaptic element

The first block represents the presynaptic element of a chemical synapse. An information transduction is required in order to obtain a chemical signal from an electrical one. In detail, this block accepts as input a voltage value v and returns as output the concentration of neurotransmitters currently released T . We assume that the input/output relationship follows a Boltzmann distribution as in [4]

$$T(v) = T_M / [1 + e^{-\frac{v - V_p}{k_p}}] \quad (1)$$

where T_M is the maximum neurotransmitters concentration that can be released, v is the presynaptic voltage or action potential at TX (i.e. input signal), V_p is called the half activation potential and k_p is a slope factor. Observe that, due to the action potential mechanism, the neurotransmitters concentration in the time domain typically exhibits an impulsive rectangular behavior and can be modeled as [4]

$$T(t) = T_M \cdot [u(t - t_0) - u(t - t_1)] \quad (2)$$

where $u(\cdot)$ is the step function and t_0 and t_1 are the time instants when the neurotransmitters release starts and ends.

Observe that, in the frequency domain, by using the Fourier transform [3], the normalized variation in the neurotransmitters concentration can be modeled as

$$H_1(f) = \text{sinc}(f(t_1 - t_0)) e^{-j2\pi f(t_1 - t_0)} \quad (3)$$

and the delay introduced is

$$D_1(f) = -d\phi_{H_1}/df = 2\pi(t_1 - t_0) \quad (4)$$

This output concentration is propagated through the synaptic cleft. Accordingly, a variation in the neurotransmitters concentration occurs as a function of the distance traveled in the cleft. In the following section, this diffusion through the synaptic cleft will be characterized.

B. Channel

Usually the diffusion of the neurotransmitters across the synaptic cleft is not modeled [4] and the synaptic cleft is considered as a reliable channel which does neither attenuate nor introduce any delay in the signal propagation. Instead, an accurate characterization of signal propagation requires to consider also the neurotransmitters diffusion in the cleft. Accordingly, in this section, we recall the main aspects of the particle diffusion process described in [14] to model through a diffusive approach this propagation of neurotransmitters.

Let us consider a concentration T of neurotransmitters which travel through the synaptic cleft, which size is d_{Cleft} . By using the diffusion theory [15], and, in particular, the second Fick's law and the Telegraph equation [15], the concentration variation inside the cleft can be modeled using a normalized gain function as [14]

$$H_2(f) = \frac{\int_{-\infty}^{+\infty} g(d_{Cleft}, t) e^{-j2\pi ft} dt}{\max_f(\int_{-\infty}^{+\infty} g(d_{Cleft}, t) e^{-j2\pi ft} dt)} \quad (5)$$

where $g(\cdot)$ is the impulse response of the system and can be written as [14]

$$g(d_{Cleft}, t) = e^{-t/(2\tau)} \frac{\cosh(\sqrt{t^2 - (||x||/c)^2})}{\sqrt{t^2 - (||x||/c)^2}} \cdot u(t - ||x||/c) \quad (6)$$

being $||x||$ the distance from the presynaptic terminal, $c = \sqrt{D}/\tau$ the wavefront speed, τ the relaxation time, D the diffusion coefficient, and $u(\cdot)$ the step function.

The delay introduced by this block can be written as

$$D_2(f) = -d\phi_{H_2}/df = -d(\text{atan}(\frac{\Im(H_2(f))}{\Re(H_2(f))}))/df \quad (7)$$

C. Postsynaptic element

In the postsynaptic element we model the fact that a chemical signal associated to the concentration of neurotransmitters released causes a binding of a percentage of the neurotransmitters with ligands.

In order to completely characterize this block, we need to analyze the receptor-ligand binding process. We start by assuming that the following kinetic scheme holds [4]:



where R and T represent the receptors and neurotransmitters concentration respectively, and TR^* represents the binding concentration; α and β are the kinetic constants of the two-directions reactions. We also assume that the total postsynaptic receptor concentration $[A]$ is constant, which means that $[R] + [TR^*] = [A]$.

Then, we define r as the fraction of bound receptors, i.e. $r = \frac{[TR^*]}{[A]}$.

According to a first order kinetic scheme [4], the following equation can be written

$$dr/dt = \alpha T(t)(1 - r(t)) - \beta r(t) \quad (9)$$

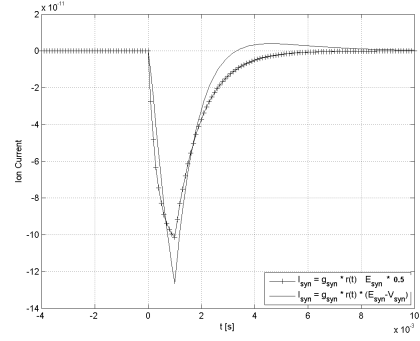

Fig. 3. Synaptic current.

The normalized gain associated to this block can be written by solving eq. (9) as follows:

$$H_3(f) = \frac{\alpha - \alpha r_0}{\beta + j2\pi f} \cdot \left[\max_f \left(\frac{\alpha - \alpha r_0}{\beta + j2\pi f} \right) \right]^{-1} \quad (10)$$

where r_0 is the value of the fraction of bound receptors at t_0 . The delay associated to this postsynaptic element will be

$$D_3(f) = -d\phi_{H_3}/df = -d(-\text{atan}(2\pi f/\beta))/df \quad (11)$$

D. Ion current generator

If neurotransmitter-ligand binding causes directly an ion channel opening, total conductance through all channels can be written as $G(t) = g_{syn}r(t)$ where g_{syn} is the maximum synaptic conductance.

Concluding, synaptic current resulting from this process is defined as follows:

$$I_{syn}(t) = g_{syn}r(t)(E_{syn} - V_{syn}(t)) \quad (12)$$

where $V_{syn}(t)$ is the membrane potential of the postsynaptic cell, i.e. $V_{syn}(t) = I_{syn}(t)Z_{syn}$ and E_{syn} is the synaptic reversal potential. Observe that, typically, the membrane potential is negligible with respect to the synaptic reversal potential. This can be seen in Fig. 3 where the synaptic current behavior is shown both in the exact expression given in eq. (12) and in the simplified case where the membrane potential is neglected and the current is approximated as

$$I_{syn}(t) \approx 0.5 \cdot g_{syn}r(t)E_{syn} \quad (13)$$

Looking at Fig. 3 it can be seen that the approximate expression well fits the real behavior while highly simplifying the reasoning. Accordingly, the normalized gain of this block, $H_4(f)$, which can be obtained from the simplified expression in eq. (13), is unitary and the delay introduced, $D_4(f)$, is zero because the phase is $\Phi_4(f) = 0$ if $E_{syn} \geq 0$ or $\Phi_4(f) = \pi$ if $E_{syn} < 0$.

E. Membrane Potential Generator

This block represents the process according to which synapse current is transduced into the membrane potential. In this section we present the mechanism of this transduction and how the generated signal is propagated through the neuron. To this purpose, we use the one-dimensional neuron model called *Leaky Integrate and Fire* [4].

This model shown in Fig. 4(a) can be represented as an equivalent RC parallel circuit driven by a current $I_{syn}(t)$. This current can be split into two components: I_R , which flows through the linear resistor R_m modeling the resistive effects of the membrane, and I_C , which charges the capacitor C_m , modeling the capacitive effects of the membrane. The former can be computed using the Ohm law, $I_R = V_{syn}(t)/R_m$ and the latter is computed as $I_C = C_m dV_{syn}/dt$. Therefore, using the exact expression in eq. (12) we find:

$$C_m \frac{dV_{syn}(t)}{dt} + \frac{V_{syn}(t)}{R_m} = g_{syn} E_{syn} r(t) - g_{syn} r(t) V_{syn}(t) \quad (14)$$

Observe that the Leaky Integrate and Fire model is not a simple RC circuit but a threshold mechanism is used. More specifically, when the voltage across the capacitor reaches a threshold value denoted as θ , a spike is generated (i.e. the action potential) and is propagated through the axon. If the threshold is not reached, the action potential cannot be generated. Using the Fourier Transform, the normalized gain function of the LIF block can be characterized as

$$H_5(f) = (1 + j2\pi f R_m C_m)^{-1} \quad (15)$$

and the associated delay is

$$D_5(f) = -d\phi_{H_5}/df = d(\text{atan}(2f\pi R_m C_m))/df \quad (16)$$

Using the results of the previous subsections, we could appropriately design the incoming voltage v at the presynaptic element such that the action potential can be generated at the output of the membrane potential generator block.

F. Axon

When the action potential is generated as a consequence of the threshold achievement in the Leaky Integrate and Fire block, it propagates along the axon. Let us remind that the myelin sheath is occasionally interrupted at Ranvier nodes. At these locations, the action potential is regenerated so that it does not come at the axon terminal button too attenuated; in fact, in this case, it could not stimulate any synaptic communication. Accordingly, the axon block can be modeled through a block introducing a unit gain $H_6(f) = 1$ and a constant delay $D_6(f) = \Psi$.

IV. ANALYSIS

In this section we will discuss the gains and delays introduced by the different blocks illustrated above.

The presynaptic element normalized gain of eq. (3) is shown in Fig. 6(b). We observe that the presynaptic element behaves like a low pass filter with a bandwidth of about 1 kHz

and introduces a fixed delay as in eq. (4) of about 6.3 ms, proportional to the interval during which the neurotransmitters concentration is not zero. The higher the interval length, the higher the introduced delay and the lower the filter bandwidth. This figure has been obtained by assuming $t_1 - t_0 = 1ms$ which is a standard duration for the action potential [4].

In Fig. 6(b) we show also the normalized gain in eq. (5) achieved by the channel (i.e. the synaptic cleft). Observe that the gain increases as a function of the frequency. More specifically, in [0.1, 10] Hz the neurotransmitter concentration increases according to a parabolic behavior. Then, in [10, 1000] Hz neurotransmitters' concentration remains almost constant and starts rising significantly again for frequencies higher than 1 kHz.

Concerning the delay introduced by the channel and illustrated in eq. (7) as shown in Fig. 5, in the range [0.1, 10] Hz the block does introduce a constant delay of less than 5 ns. Then, the delay introduced decreases rapidly and for higher frequencies starts increasing slowly again. However observe that the introduced delay is always negligible with respect to the one added by the first block.

The normalized gain of the third block in eq. (10), i.e. the postsynaptic element, exhibits a low pass behavior as shown in Fig. 6(b). Concerning the delay contribution in eq. (11), observe in Fig. 5 that the contribution to the delay due to the postsynaptic element is lower than 6.5 ms, so, in the worst case, comparable to the contribution to the delay given by the first block.

Let us now discuss on the membrane potential generator block. As observed in the description, it is necessary that the voltage across the capacitor C_m is at least equal to θ in such a way that the action potential can be generated. In fact, let us remember that it is necessary that the voltage across the capacitor reaches the threshold value so that the all-or-none action potential generation can take place. Accordingly, in order to foster the action potential propagation from the input of the presynaptic element to the axon terminal button, it is necessary that the normalized gain between the voltage across the capacitor and the initial action potential is around $\frac{\theta}{V_{AP}}$ where V_{AP} is the action potential. As an example, looking at Fig. 4(b) from [4] we have that $\frac{\theta}{V_{AP}} \geq 0.35$ where $\theta = 30$ mV and $V_{AP} = 55$ mV.

In Fig. 6.a we show the required normalized gain given by the product of eqs. (3), (5), (10), and (15). The overall behavior in terms of normalized gain can be assimilated to a band pass filter with a useful bandwidth of about 80 Hz. The overall delay in the corresponding frequency interval, as shown in Fig. 6.b, is the range [3.5, 33] ms and is given by the sum of the delays introduced by the previous blocks. Finally, concerning the propagation in the axon which implies a regeneration in the action potential, the normalized gain can be considered unvaried but the delay is increased of the amount of time needed to regenerate the signal at each Ranvier node multiplied by the number of Ranvier nodes involved. Approximately, it is said that the propagation velocity of an electric pulse in the axon is around 100 m/s [4] which leads, in

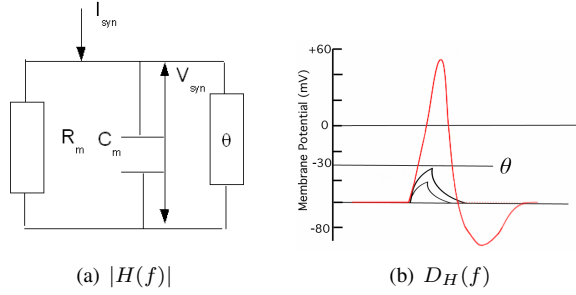

Fig. 4. a) Leaky Integrate and Fire (LIF) model and b) Action potential.

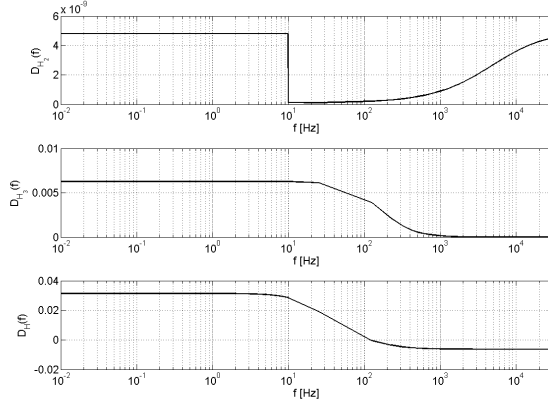

Fig. 5. Delay introduced by a) channel ($D_1(f)$) b) the postsynaptic element ($D_2(f)$) c) Delay introduced by the sequence of the first four blocks.

case for example of an axon length of 1 m (e.g. for the ischiatic nerve), to an additional delay of about 10 ms. Accordingly, the overall delay for the propagation of an impulse between two neurons is in the range [13.5, 43] ms. The useful frequency bandwidth where it is possible for a nanomachine to effectively communicate with a neuron is around [3, 84] Hz.

V. CONCLUSIONS AND FUTURE WORK

In this paper we presented a hybrid molecular/electromagnetic model for nanomachine-to-neuron signal propagation in biological networks. The proposed solution is thought to allow communication between biologic elements (i.e. neurons) and nanomachines which, in the next future, could interact to support communication across damaged branches of the human body where, due for example to an accident, nervous impulses cannot propagate.

The overall communication system is organized into blocks, the behavior of which has been characterized in terms of delay and normalized gain as a function of the frequency. Results show that there is a range of frequencies where a nanomachine, structured according to the blocks identified above, could successfully communicate with a neuron by also introducing a delay which is compatible with the human reaction time.

REFERENCES

[1] I. F. Akyildiz, F. Brunetti, C. Blazquez. Nanonetworks: A new communication paradigm. *Elsevier Computer Networks*. June 2008.

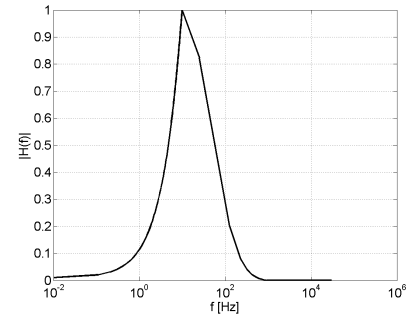

(a) $|H(f)|$

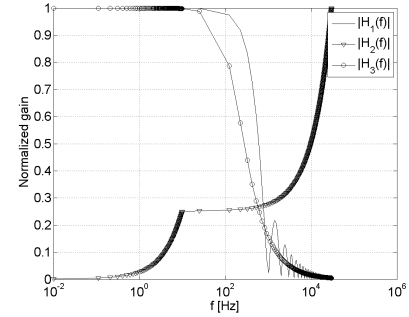

(b) $D_H(f)$

Fig. 6. a) Normalized Gain and b) Normalized gain for $|H_1(f)|$, $|H_2(f)|$ with $d_{Cleft} = 20nm$ $D = 10^{-6}m^2s^{-1}$ $\tau = 1ns$, and $|H_3(f)|$ with $\alpha = 2ms^{-1}mM^{-1}$ $\beta = 1ms^{-1}$ $r_0 = 10^{-7}$.

[2] B. Atakan and O. B. Akan. Carbon Nanotube-Based Nanoscale Ad Hoc Networks. *IEEE Communications Magazine*. June 2010.

[3] B. Davies. Integral transforms and their applications. *Springer Eds. 2002*

[4] G. L. Fain. Molecular and cellular physiology of neurons. *Harvard University Press* 1999.

[5] M. Gregori and I. F. Akyildiz. A New NanoNetwork Architecture Using Flagellated Bacteria and Catalytic Nanomotors. *IEEE JSAC*. May 2010.

[6] S. Hiyama, Y. Moritani, T. Suda, R. Egashira, A. Enomoto, M. Moore and T. Nakano. Molecular Communication. *NSTI Nanotechnology Conference*. May 2005.

[7] K.Jensen, J.Weldon, H.Garcia, A.Zettl. Nanotuberadio. *NanoLetters*. November 2007.

[8] J. M. Jornet and I. F. Akyildiz. Graphene-Based Nano-Antennas for Electromagnetic Nanocommunications in the Terahertz Band *EUCAP*. April 2010.

[9] J. M. Jornet and I. F. Akyildiz. Channel Capacity of Electromagnetic Nanonetworks in the Terahertz Band. *IEEE ICC* May 2010.

[10] J. M. Jornet and I. F. Akyildiz. Electromagnetic wireless nanosensor networks. *Elsevier Nano Communication Networks Journal* June 2010

[11] M. Moore, A. Enomoto, T. Nakano, R. Egashira, T. Suda, A. Kayasuga, H. Kojima, H. Sakakibara, K. Oiwa. A design of a molecular communication system for nanomachines using molecular motors. *IEEE PerCom*. March, 2006.

[12] T. Nakano, T. Suda, M. Moore, R. Egashira, A. Enomoto, and K. Arima. Molecular Communication for Nanomachines Using Intercellular Calcium Signaling. *IEEE NANO*. June 2005.

[13] L. Parcerisa Gin and I. F. Akyildiz. Molecular communication options for long range nanonetworks. *Elsevier Computer Networks*. Aug. 2009.

[14] M. Pierobon and I. F. Akyildiz. A Physical End-to-End Model for Molecular Communication in Nanonetworks. *IEEE JSAC*. May 2010.

[15] B. Thide'. Electromagnetic Field Theory, 2nd Eds. Online Textbook <http://www.plasma.uu.se/CED/Book/index.html>.

[16] J. Weldon, K. Jensen, A. Zettl. Nanomechanical radio transmitter. *Physica Status Solidi*. October 2008.